

Demontage / Démontage /
Disassembly / Smontare

Spray-Matic 1.25 P
Spray-Matic 1.25 N
Clean-Matic 1.25 P
Foam-Matic 1.25 P
116 148 02-SB

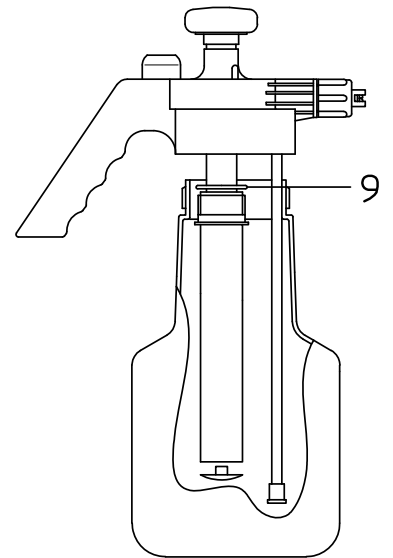

Vorherige Version / Version ancienne
Previous version / Versione vecchia

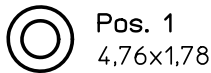

Pos. 1
4,76x1,78

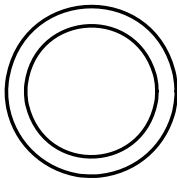

Pos. 4
11x2,5

O-Ringe
Joints toriques
O-Rings
Anelli di gomma

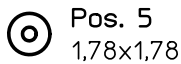

Pos. 5
1,78x1,78

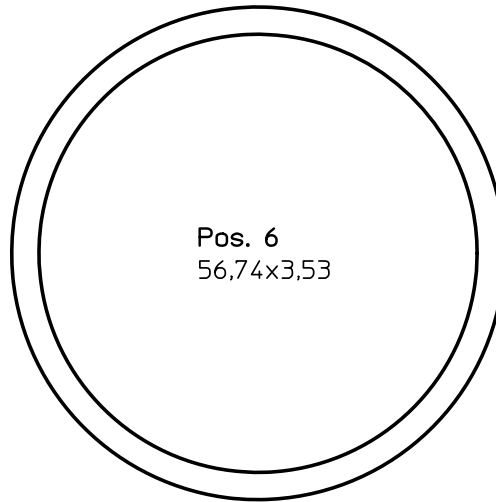

Pos. 6
56,74x3,53

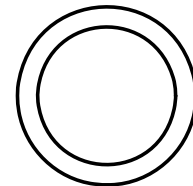

Pos. 7
17,86x2,62

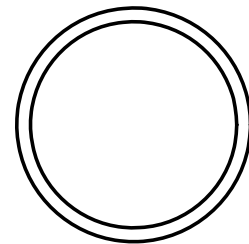

Pos. 9
26,7x1,78

Flachdichtungen
Joints
Flat gaskets
Guarnizione piatta

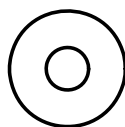

Pos. 2
15x5,5x2